

# Specifications for Approval

Customer Part No.:

JOINHANDS Part No.: JH-CMRBK06GTP005

Part Name: 1615 红蓝双色 LED

Spec Issue Date:2019-01-21

Revision No.: A0

=====

To Customer:

1. Accessory: Samples  Samples Data
2. Customer's Proposal :Agree Disagree

Reason :

Draw by :	Checked by :	Approved by :
李飞	卢伟昌	钟志鸿
Customer Approve		



广东晶瀚光电科技有限公司  
GUANGDONG JOINHANDS Optoelectronics Technology Co.,Ltd  
地址:东莞市寮步镇塘边社区华南工业城金富路 13 号  
鼎昊自动化孵化园 2 区 B 栋 101 号  
Tel:0769-82233086 Fax:0769-82233606  
<http://www.joinhands-cn.com>  
E-mail: hanser.yu@joinhands-cn.com

## Features

1.6mm X 1.5mm SMD LED, 0.6mm thickness

Low power consumption

Wide view angle

Package: 4000pcs/reel

RoHS Compliant

## Applications

Ideal for back light and indicator

Various colors and lens types available

## Package outlines

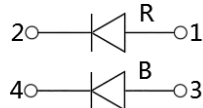
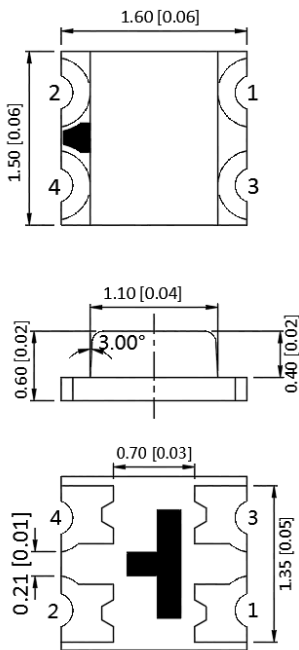

## Recommend Pad Layout

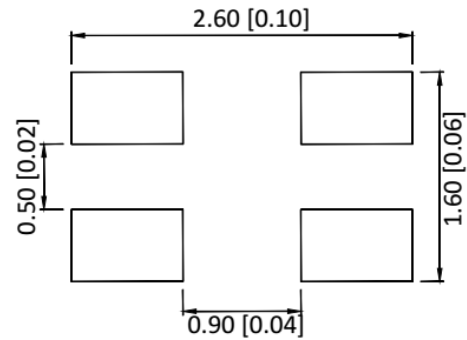

Part No.	Emitted color	Dice	Lens color
JH-CMRBK06GTP005	Red	AlGaInP	Water transparent
	Blue	InGaN/GaN	

## Notes:

1. All dimensions are in millimeters (inches);
2. Tolerances are  $\pm 0.1\text{mm}$  (0.004inch) unless otherwise noted.

**Absolute Maximum Ratings (Ta=25 °C)**

Parameter	Symbol	Value		Unit
		R	B	
Forward current	If	25		mA
Reverse voltage	Vr	5		V
Power dissipation	Pd	72	111	mW
Operating temperature	Top	-40 ~+85		°C
ESD(Human-body mode)	--	4	2	KV
Storage temperature	Tstg	-40 ~+85		°C
Peak pulsing current (1/8 duty f=1kHz)	Ifp	125		mA

**Electro-Optical Characteristics (Ta=25 °C)**

Parameter	Test Condition	Symbol	Value			Unit
			Min	Typ	Max	
Wavelength at peak emission	If=20mA	R	--	635	--	nm
		$\lambda_p$ B	--	465	--	
Spectral half bandwidth	If=20mA	R	--	20	--	nm
		$\Delta\lambda$ B	--	25	--	
Dominant wavelength	If=20mA	R	620	--	630	nm
		$\lambda_d$ B	465	--	475	
Forward voltage	If=20mA	R	1.8	--	2.4	V
		Vf B	2.8	--	3.7	
Luminous intensity	If=20mA	R	63	90	160	mcd
		Iv B	80	100	200	
Viewing angle at 50% Iv	If=10mA	2 $\theta$ 1/2	--	120	--	Deg
Reverse current	Vr=5V	Ir	--	--	10	$\mu$ A

**Relative Spectral Emission (Red)**

IF=20mA, Ta=25°C

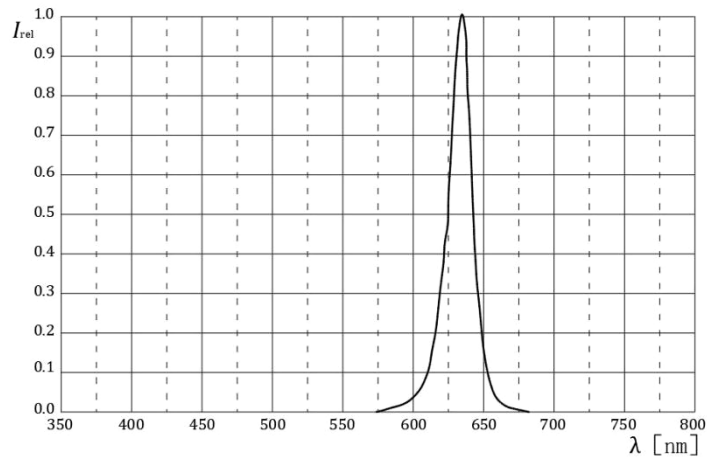

**Radiation Characteristics**

IF=10mA, Ta=25°C

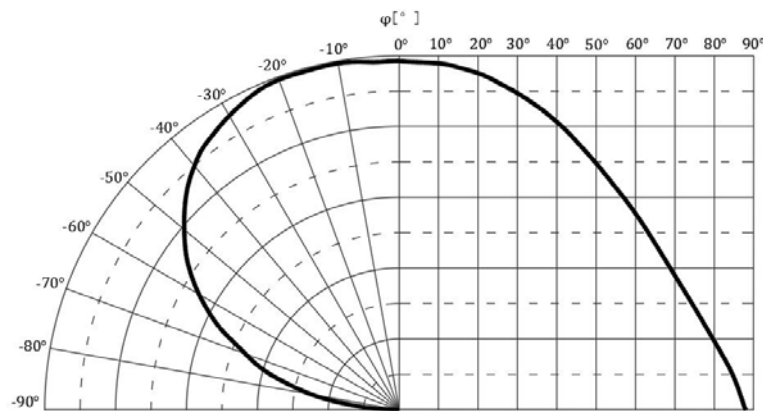

**Forward Current vs Forward Voltage Forward Current Derating Curve**

Ta=25°C

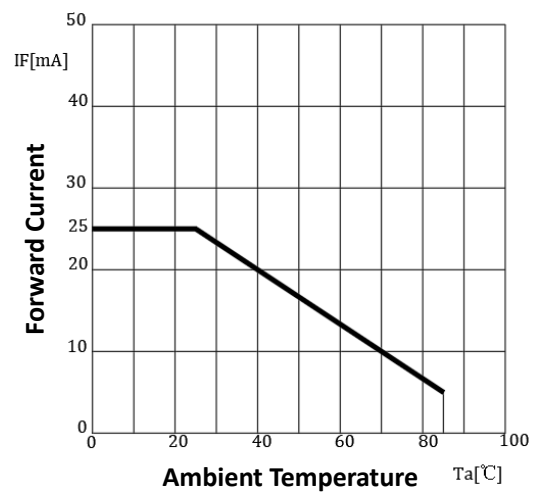
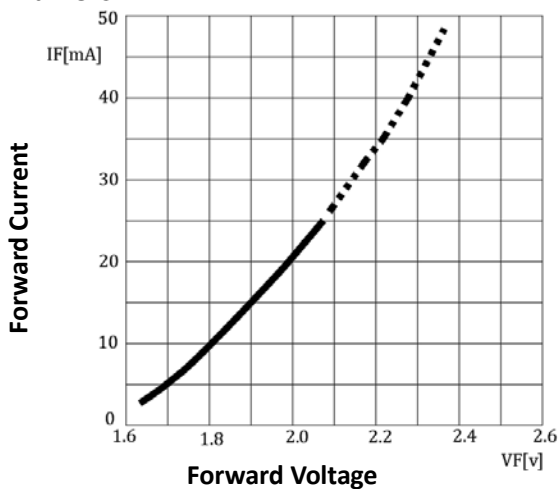

**Relative Spectral Emission (Blue)**

IF=20mA, Ta=25°C

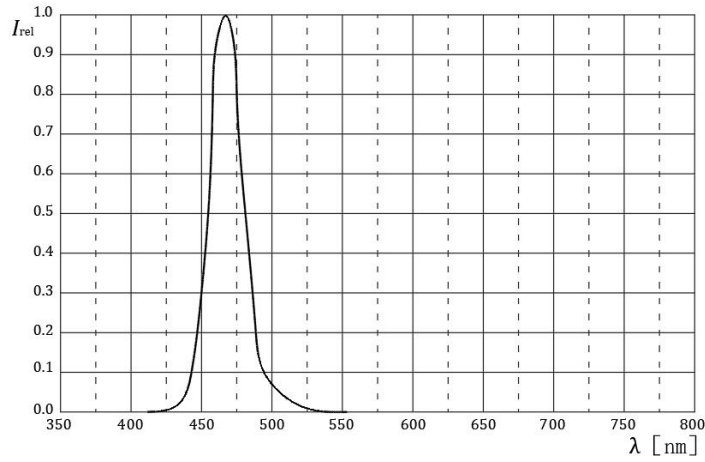

**Forward Current vs Forward Voltage**

IF=10mA, Ta=25°C

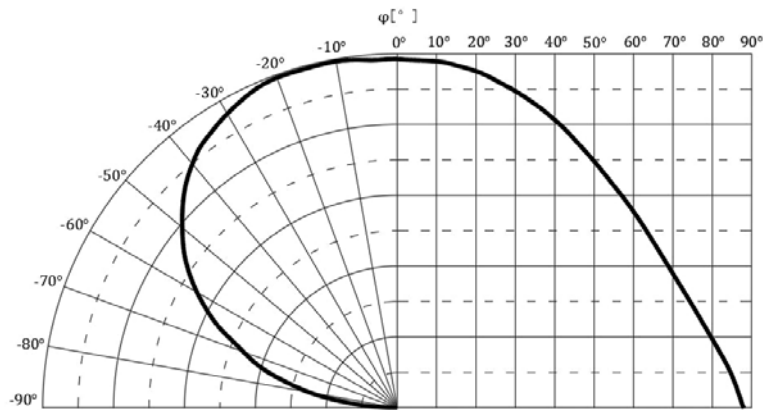

**Forward Current vs Forward Voltage Forward Current Derating Curve**

Ta=25°C

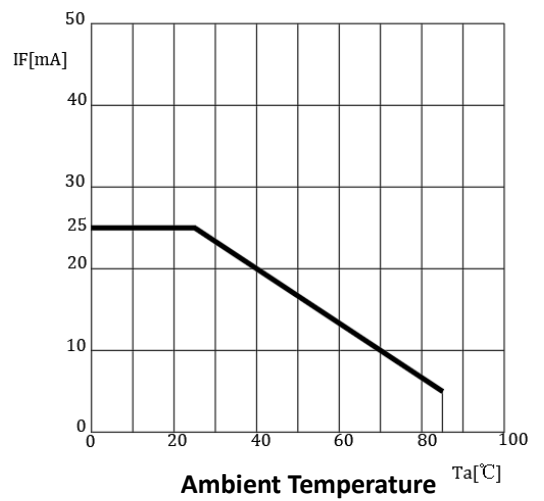
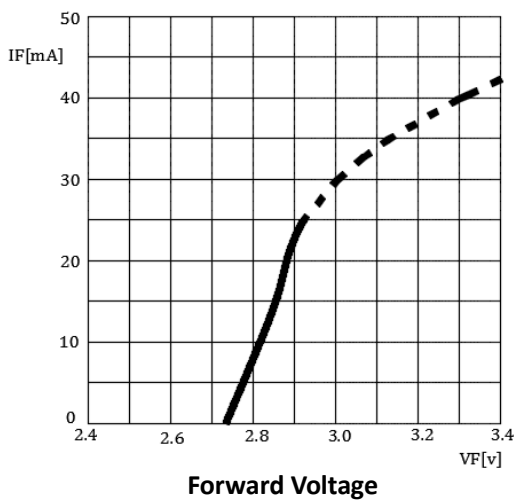

**Reflow Profile**

■ Reflow Temp/Time

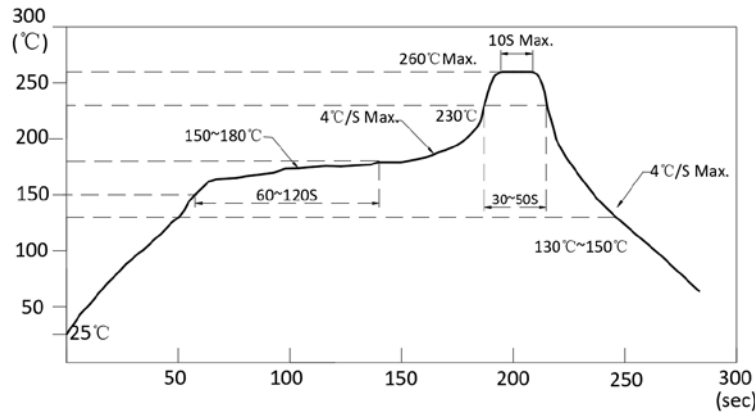

Notes:

1. We recommend the reflow temperature 245°C(±5°C).The maximum soldering temperature should be limited to 260°C.
2. Don't cause stress to the epoxy resin while it is exposed to high temperature.
3. Number of reflow process shall be 2 times or less.

■ Soldering iron

Basic spec is ≤ 5sec when 320°C(±20°C). If temperature is higher, time should be shorter(+10°C → -1sec). Powerdissipation of iron should be smaller than 20W, and temperatures should be controllable. Surface temperature of the device should be under 350°C.

■ Rework

1. Customer must finish rework within 5 sec under 340°C.
2. The head of iron cannot touch copper foil
3. Twin-head type is preferred.

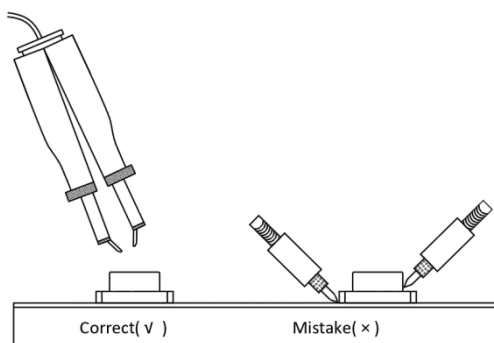

- Avoid rubbing or scraping the resin by any object, during high temperature, for example reflow solder etc.

**Handling precautions**

1. Drive Method

A LED is a current-operated device. In order to ensure intensity uniformity on multiple LEDs connected in parallel in an application, it is recommended that a current limiting resistor be incorporated in the drive circuit, in series with each LED as shown in Circuit below.

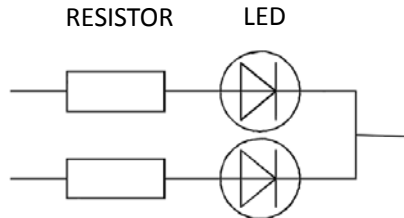

2. Storage

2.1 Do not open moisture proof bag before the products are ready to use.

2.2 Before opening the package: The LEDs should be kept at 30°C or less and 60% RH or less.

2.3 After the package is opened, the products should be used within a week or they should be kept to store at  $\leq 20^{\circ}\text{C}$  with zip

3. Baking

It is recommended to baking before soldering when the pack is unsealed after 72hrs. The Conditions are as followings:

3.1  $60\pm 3^{\circ}\text{C}$  x(12~24hrs) and  $< 5\% \text{RH}$ , taped reel type

3.2  $100\pm 3^{\circ}\text{C}$  x(45min~1hr), bulk type

3.3  $130\pm 3^{\circ}\text{C}$  x(15~30min), bulk type

## Test Items and Results of Reliability

Test Item	Test Conditions	Standard Test Method	Note	Number of Test
Reflow Soldering	Ta=260±5℃,Time=10±2S	JB/T 10845-2008	3times	0/22
Salt Atmosphere	Ta=35±3℃,PH=6.5~7.2	GB/T 2423.17-2008	24hrs	0/22
Temperature Cycling	-40±5℃ 30±1min ↑→(25℃/5±1min)↓ 100±5℃ 30±1min	GB/T 2423.22-2012	100cycles	0/22
Thermal Shock	Ta=-40±5℃~100±5℃, 15±1min dwell	GB/T 2423.22-2012	100cycles	0/22
High Humidity High Temp. Cycling	Ta=30±5℃~65±5℃, 90±5%RH,24hrs/1cycle	GB/T 2423.4-2008	10cycles	0/22
High Humidity High Temp. Storage Life	Ta=85±5℃,ψ(%)=85±5%RH	GB/T 2423.3-2006	1000hrs	0/22
High Temperature Storage Life	Ta=100±5℃,non-operating	GB/T 2423.2-2008	1000hrs	0/22
Low Temperature Storage Life	Ta=-40±5℃,non-operating	GB/T 2423.1-2008	1000hrs	0/22
Life Test	Ta=26±5℃,@20mA, ψ(%)=25%RH~55%RH	--	1000hrs	0/22
High Humidity High Temp. Operating Life	Ta=85±5℃,@20mA, ψ(%)=85%RH	GB/T 2423.3-2006	500hrs	0/22
Low Temperature Operating Life	Ta=-20±5℃,@20mA	GB/T 2423.1-2008	1000hrs	0/22



### Forward Voltage Rank Combination (IF=20mA)

Rank		Min.	Max.	Unit
Red	□	1.8	2.4	V
	f	2.8	3.1	
Blue	g	3.1	3.4	
	h	3.4	3.7	

### Luminous Intensity Rank Combination (IF=20mA)

Rank		Min.	Max.	Unit
Red	H	63	80	mcd
	I	80	100	
	J	100	125	
	K	125	160	
Blue	I	80	100	
	J	100	125	
	K	125	160	
	L	160	200	

### Dominant wavelength Rank Combination(IF=20mA)

Rank		Min.	Max.	Unit
Red	t	620	625	nm
	u	625	630	
Blue	G	465	467.5	
	H	467.5	470	
	I	470	472.5	
	J	472.5	475	

Group Name on Label ( Example DATA: □lufJH 20 )

DATA: □lufJH20		Vf(V)	Iv (mcd)	λd (nm)	Test Condition
Red	□→I→u→20	1.8~2.4	80~100	625~630	IF=20mA
Blue	f→J→H→20	2.8~3.1	100~125	467.5~470	

Notes:

1. The tolerance of luminous intensity (Iv )is  $\pm 15\%$  .
2. The tolerance of dominant wavelength is  $\pm 1\text{nm}$ .
3. This specification is preliminary.
4. This specification is a standard specification of our factory, can make in accordance with customer's special requirement.

**1615 Series SMD Chip LED Lamps Packaging Specifications**

● **Feeding Direction**

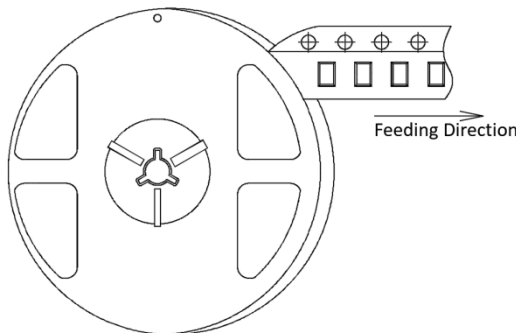

● **Dimensions of Reel (Unit: mm)**

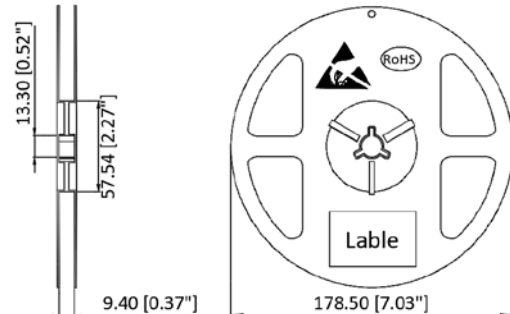

● **Dimensions of Tape (Unit: mm)**

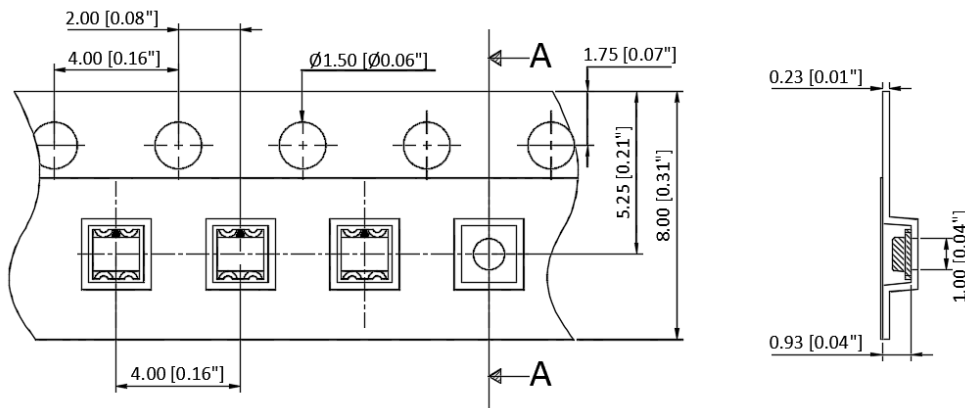

● **Arrangement of Tape**

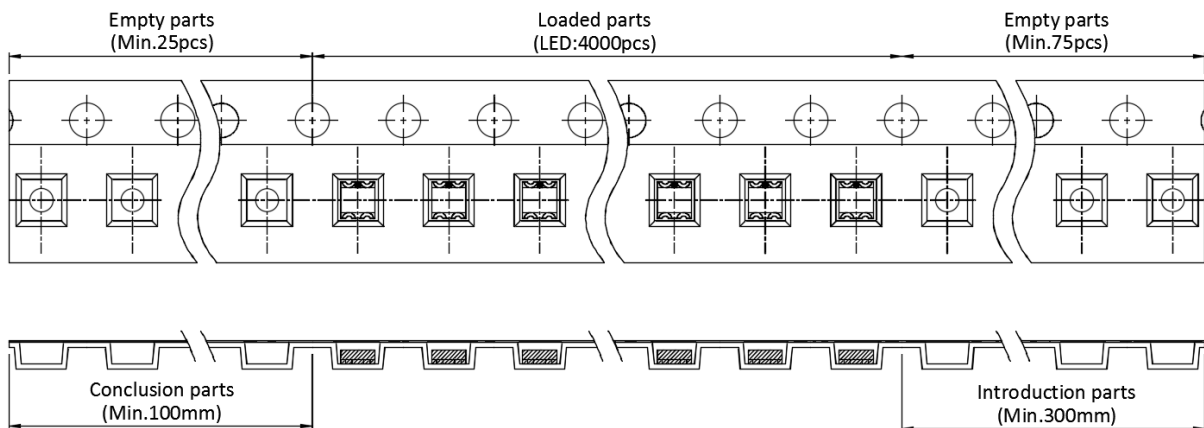

**Notes:**

1. Empty component pockets are sealed with top cover tape;
2. The maximum number of missing lamps is two;
3. The cathode is oriented towards the tape sprocket hole in accordance with ANSI/EIA RS-481 specifications.
4. 4,000pcs/Reel.

## 1615 Series SMD Chip LED Lamps Packaging Specifications

- Label Explanation



CPN:Customer's Product Number  
 P/N:Product Number  
 QTY:Packing Quantity  
 LOT NO:Lot Number  
 VF:Forward Voltage Rank  
 IV:Luminous Intensity Rank  
 WLD:Dom. Wavelength Rank  
 BIN:BIN Code  
 DATE:Date Of Dispatch

- Transportation Packing

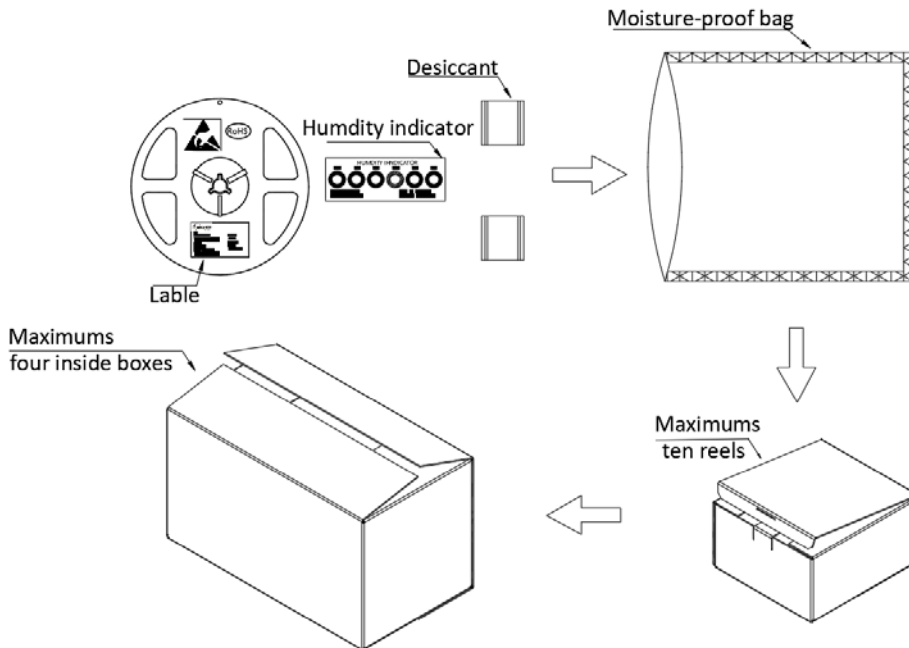

Notes:

Reeled products (numbers of products are 4,000pcs) packed in a seal off moisture-proof bag along with two desiccant one by one, ten moisture-proof bag of maximums packed in an inside box (about size: 240x 220x 120mm) and four inside boxes of maximums are put in the outside box (about size: 460mm x 246mm x 250mm) Together with buffer material, and it is packed. The number of the loading steps of outsidebox (cardboard box) has it to three steps.